

Wireless CO2 Recorder RTR-576 User's Manual

Thank you for purchasing our product. To ensure safe and proper operation, please read this manual thoroughly before use.

| RTR-576 Package Contents | RTR-576-S Package Contents |
|---|---|
| <ul style="list-style-type: none"> Wireless CO2 Recorder (RTR-576) Temperature-Humidity Sensor (THA-3001) AC Adaptor (AD-06C1) USB Mini-B Cable (US-15C) AA Alkaline Battery LR6 x 4 Manual Set (Warranty Included) | <ul style="list-style-type: none"> Wireless CO2 Recorder (RTR-576) High Precision Temperature-Humidity Sensor (SHA-3151) AC Adaptor (AD-06C1) USB Communication Cable (US-15C) AA Alkaline Battery x 4 Manual Set (Warranty Included) |

T&D Corporation
https://tanadd.com/

© Copyright T&D Corporation. All rights reserved.
2024.10 16504800035 (12th Edition)



Part Names and LCD Display

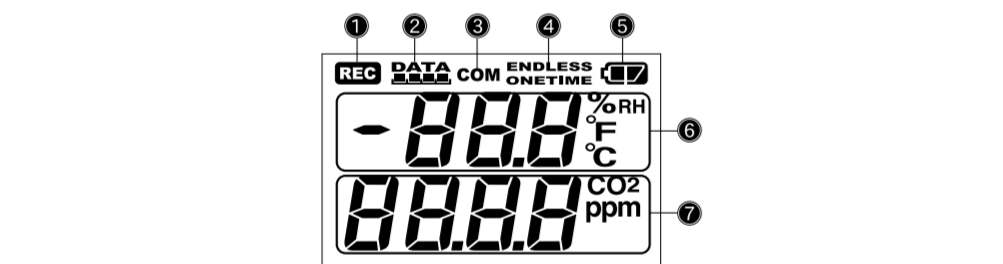
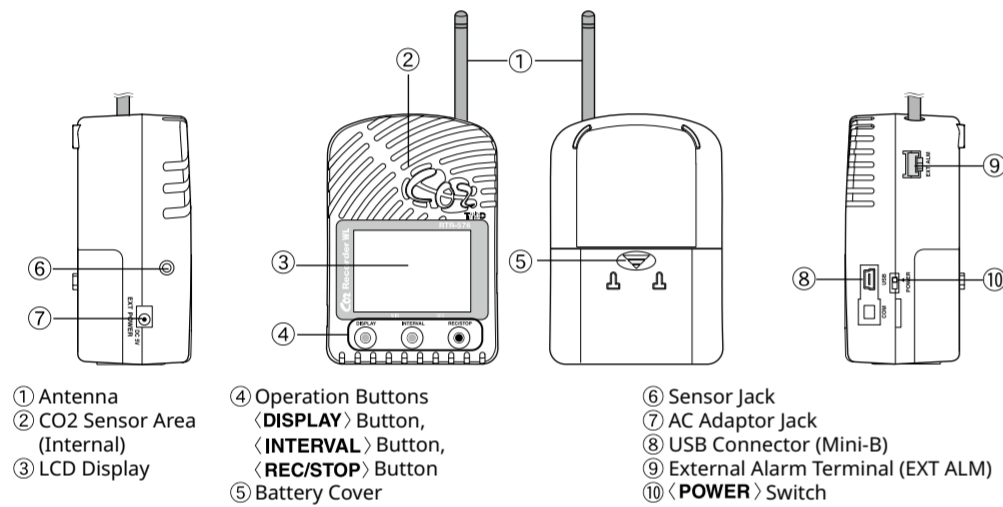

| | |
|---|--|
| 1 [REC] Mark | Shows recording status ON: Recording in progress BLINKING: Waiting for programmed start OFF: Recording stopped |
| 2 Data Scale | At the beginning of every 2,000 readings the scale will be marked from left to right. Logging capacity is 8,000 readings. |
| 3 [COM] Mark | Shows communication status but not displayed normally. ON: The unit is connected to a PC with a USB cable. RAPID BLINKING: The unit is in communication via USB or wireless communication. |
| 4 Rec. Mode | Recording mode settings can be made by using the software. Endless: Upon reaching the logging capacity of 8,000 readings, the oldest data will be overwritten and recording will continue. One Time: Upon reaching the logging capacity of 8,000 readings, recording will automatically stop and in the LCD the current measurement and the word "FULL" will alternately appear. |
| 5 Battery Mark | Shows source of power and voltage level. (See "Interpreting the Battery Mark" for details.) |
| 6 Current Temperature and Humidity Readings Area | Shows the current readings for temperature (°C / °F) and humidity (%RH). Pressing the <DISPLAY> button will change the measurement item to be displayed. This area is also used to display messages. |
| 7 Current CO2 Readings Area | Shows the current readings for CO2 concentration (ppm). This area is also used to display messages. |

Messages and Display on the LCD Settings Messages

| | |
|--|---|
| | Button Lock When "Button Lock" has been set to ON in the software, operational buttons are not active. |
| | Memory Full When recording mode has been set to "One Time" and the unit reaches its logging capacity of 8,000 readings, the measurement and the message [FULL] will alternately appear in the LCD. Stop recording and download the recorded data before re-starting recording. Memory "FULL" does not occur when in "Endless" mode. |

Notes about Operation

- This product has been designed for use in normal living conditions, and is not suited for controlled environments such as a CO2 incubator. When measuring outdoors, avoid exposure to sunlight, dust, rain, or wind. Also make sure to use in the operating environment indicated in the specifications.
- This product cannot measure CO or O2. Do not use it for purposes such as avoiding O2 deficiency, CO intoxication or any other health related purpose.
- For one to two weeks after installation of the unit, CO2 concentration measurements may fluctuate suddenly. This is due to the normal operation of Auto Calibration and is not a malfunction of the RTR-576.
- Do not use or store the unit in areas exposed to direct sunlight and abrupt changes in temperature.
- Do not allow the unit to become wet. Do not use or store the unit in places where condensation occurs.
- To help prevent deterioration of the unit, do not use or store the unit in areas exposed to cigarette smoke, corrosive, explosive or organic gases or dust in the air.
- Do not expose the unit to a strong impact. This will adversely affect measurement accuracy and may cause the case to break resulting in bodily injury.
- The measurement accuracy of the CO2 sensor can not be guaranteed for CO2 concentrations of 5,000ppm or more.
- As a Remote unit, RTR-576 requires a Base Unit to carry out wireless communication.
(Compatible Base Units: RTR500BW, RTR500BM, RTR500BC)
- Please set up the Base Unit first before the RTR-576.

Interpreting the Battery Mark

Checking the Power Supply Condition

Whether the battery mark is "blinking" or "on" indicates the source of power. This mark will not appear when batteries are not installed.

BLINKING (Running on battery):
The battery mark will blink on the LCD display when operating on battery power only.

ON (Running on external power):
The battery mark will be on when using the AC adaptor.

Checking the Battery Level

The battery level will be shown in three stages as below.

- Battery Power - OK**
- Battery Power - Getting Low**
It is recommended to change the batteries as soon as possible.
- Battery Power - Too Low**
If the battery power has become low while running on batteries only, it is impossible to measure and record CO2 concentration. Also, errors may occur during wireless communication.

- When running on batteries only, it will take about 24 hours to go from Stage ① to ② and another 24 hours from Stage ② to ③.

- Sleep Mode (stopping measurement and recording)**
After Stage ③, if the batteries are not changed but remain in use, the unit will enter sleep mode and stop measurement and recording in order to protect recorded data until this point.
 - Upon replacing the batteries with new ones, the display will return to the current readings display.
 - Download the recorded data into the PC before re-starting recording.

- Erasing recorded data**
If the battery is further left unchanged, the display will automatically shut off and all previously recorded data will be lost.

Removing the Batteries during Recording

- If the batteries are removed when running on battery power only, the Unit will start a sixty-second countdown.
- To continue recording, before the countdown comes to an end, insert new batteries or connect the AC adaptor to supply power.
- If power is not supplied within 60 seconds, the Unit will enter sleep mode.

When [----] appears in the following:

Temperature and Humidity Display Area
This appears when the Temperature-Humidity sensor is not connected to the RTR-576, the connection is loose, the wire is broken, or when power has just been turned ON. If after re-connecting the sensor, measurements can still not be displayed, it is very possible that the sensor or the logger is defective or has been damaged.

CO2 Concentration Display Area
This appears when power has just been turned ON. If measurements don't appear in the display after waiting for a considerable time, there is a possibility that the sensor is defective or has been damaged. Also, the CO2 sensor will not work if battery power is low.

Setting up the RTR-576

Do not connect an RTR-576 to your computer before first installing the software for the Base Unit.

STEP 1 Connect the Sensor

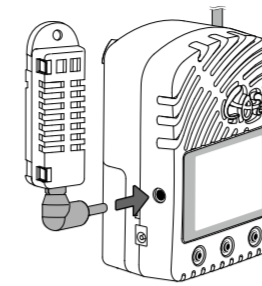

STEP 2 Turn ON the Power

AC Adaptor

When measuring and recording over long periods of time, please use a supplied AC adaptor.

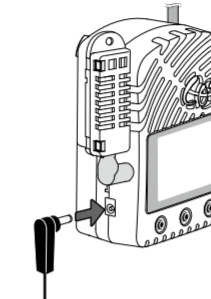

Four AA Alkaline Batteries

If running on only batteries, the estimated battery life is about two days. Keeping batteries in the unit allows a backup source of power for when and if electrical power is cut from the AC adaptor.

- Note: When using batteries as a backup power supply, it is recommended to replace them approximately once every two years to avoid battery leakage.

Install the Battery

If battery power is lost, all recorded data stored in the unit will be erased. Do not leave the unit without batteries.

- Remove the battery cover from the back of the unit.
 - While pressing down on the triangular mark, slide the cover to the bottom of the unit.
 - Lift off the cover.

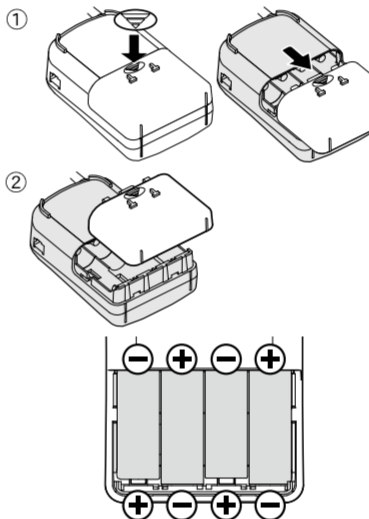

- Insert the supplied batteries.
 - Make sure to use new batteries of the same kind.
 - Make sure not to mistake + / -.
 - Do not insert or change batteries with wet hands.
 - Be sure to completely close the cover.

Button Operations

If "Button Lock" has been set to ON in the software, the operational buttons will not be active.

<REC/STOP> Button: Starting and Stopping Recording

Starting Recording

Press the <REC/STOP> button for about two seconds until the [REC] mark appears on the display.

- It is possible to start recording even while waiting for a programmed recording to start.
- Upon the start of recording, all previously recorded data in the RTR-576 will be deleted.



Stopping Recording

Press the <REC/STOP> button for about two seconds until the [REC] mark disappears from the display.



<DISPLAY> Button: Changing the LCD Display Pattern

It is possible to change the current readings display for temperature and humidity (upper row). CO2 concentration (lower row) is always displayed.

- With each pressing of the <DISPLAY> button the item on the display will change.
 - Temperature and Humidity:** The display will alternate every one second.
 - Temperature only**
 - Humidity only**
- When the desired display pattern appears, stop pressing the button.

Turn on the <POWER> switch.

After setting up the power supply, turn on the <POWER> switch.

- See <Button Operations> for notes about turning off the <POWER> switch.

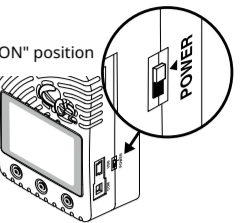

Warm-up Time for CO2 Sensor

After switching on the unit, it will take about one minute to display the normal CO2 concentration.

STEP 3 Register as a Remote Unit

Register the RTR-576 as a Remote Unit by using the Settings Utility software* for the Base Unit. After connecting the unit to your computer via USB cable, carry out registration by clicking the [Register] button in the [Remote Unit Settings] menu of the software.

* includes [RTR500BW Settings Utility], [RTR500BM Settings Utility] and [RTR500BC Settings Utility].

When the wizard window appears:

If upon USB connection, the [New Hardware Detection Wizard] opens, it is necessary to follow directions to install the USB Device Driver.

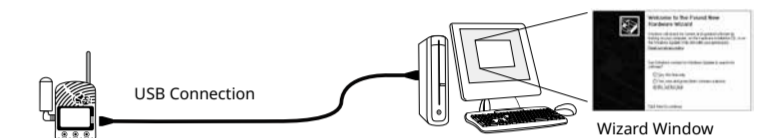

- If you have connected a unit without having installed the software, and the New Hardware Wizard has opened, please close the wizard window and disconnect the USB cable from your computer.
- For details about the installation of the USB Device Driver, access [Help for Unit Recognition Failure] from the start menu of the software.

Atmospheric Pressure Correction:

Measurement results of CO2 concentration are affected by atmospheric pressure. When high measurement accuracy is required, we recommend that Atmospheric Pressure Correction be carried out before a recording session is started.

Registration Window for RTR-576:

In the Registration Window for RTR-576, click the pull down menu of [Atmospheric Pressure Correction] to open the settings box. Directly enter the pressure (hpa) in the [Atmospheric Pressure] field.

Calculate Atmospheric Pressure from Altitude:
This setting can also be made by having the software calculate the estimated pressure at the altitude (meters) entered by the user.



<INTERVAL> Button: Checking Recording Interval

It is possible to check the recording interval during recording or while waiting for a programmed recording to start.

- By pressing the <INTERVAL> button for about two seconds, the currently set recording interval will appear on the LCD display.
- If no operation is carried out after the recording interval has been displayed, the current measurement readings will return to the LCD display.

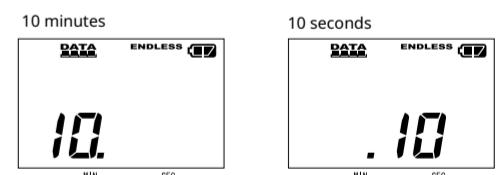

<INTERVAL> Button: Changing the Recording Interval Setting

Recording interval settings cannot be changed while a recording session is in progress.

- Stop recording.
- Press the <INTERVAL> button for about two seconds to display the currently set recording interval on the LCD screen.
- With each pressing of the <INTERVAL> button the recording interval time will change; stop pressing the button when the desired interval appears.
- Restart the recording session.

Turning Off the <POWER> Switch

During recording or when the "Button Lock" is set to ON in the software, the power cannot be turned off even by using the <POWER> switch.

- Stop recording.
- Turn off the <POWER> switch.
 - If the RTR-576 is connected to an AC adaptor, standby power will be supplied even after turning off the <POWER> switch, allowing the CO2 sensor to continue operation. Therefore, the CO2 sensor lamp will continue to flash periodically.
 - When running on battery power only, CO2 sensor stops working if the <POWER> switch is turned off.

Getting Ready to Use External Alarm Terminal

It is possible to connect an external device such as siren or lamp to the RTR-576. Please make sure to check specification details of the external alarm terminal before purchasing or getting an external device ready for connection.

About the External Alarm Terminal (EXT ALM)

| | | | | |
|----------------------|-------------------|---|-----------------------------------|---|
| | Enabling Warnings | ① | Warning Output (Enable / Disable) | Internal Pull-up: 3V 100 kΩ Maximum Input Voltage: 30V |
| | | ② | GND | |
| Warning Output (OUT) | | ③ | Output Terminal (Warning Output) | Open Drain Output Voltage when OFF: DC less than 30V Current when ON: less than 0.1A Resistance when ON: 15Ω |
| | | ④ | GND | |

The connection between ① and ② decides whether Warning Output is enabled or disabled. If a warning condition occurs while Warning Output is enabled, a connection between ③ and ④ will be established and a warning will be output.

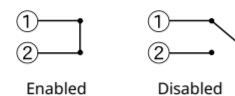

Alarm Connection Cable

The optional alarm connection cable (AC0101) is available. Please contact your local distributor for purchase.

Distributor List <https://tannd.com/purchasing/>

Auto Calibration Function for CO2 Sensor

The CO2 sensor has a calibration function (auto/manual calibration) to compensate for sensor drift that can occur over time.

Auto calibration is designed to enable long-term accurate measurements by gradually adjusting the lowest measured CO2 concentration over a 180 hour period, to the global average concentration (atmospheric CO2 level of around 400 ppm). Please turn off auto calibration when continuously measuring in an environment where the CO2 concentration is always high or low.

- The factory default setting for auto calibration is ON.
- For the operation procedures including manual calibration, refer to the Help for your Base Unit. See [RTR500B Series Help] - [RTR-574/576] - [Calibration/Adjustment Function]. Manuals & Help Downloads <https://tannd.com/manual/>

Cautions about using the Temperature-Humidity Sensors



- If extremely severe temperature changes occur, the humidity measurements may appear abnormal. Once the sensor's temperature becomes stable, the measurements will return to normal.
- Do not connect the sensor to any data logger other than those specified by T&D Corporation.
- Do not expose the sensor to a strong impact. This may adversely affect measurement accuracy and cause damage or malfunction.
- When the sensor is not to be used for a long period of time, please store it at normal temperature and humidity.
- Do not use the sensor on the human body.
- Do not expose to condensation, dampness, corrosive gases, or organic solvents.
- Continued use may cause a decrease in the sensor's accuracy and sensitivity even under normal operational conditions.
- This sensor is not water resistant. Do not allow the sensor to become wet. If the sensor gets wet, immediately remove the sensor from the unit and wipe it with a clean cloth as soon as possible. Then allow the sensor to dry in normal room temperature before using it again.
- When using the THA-3001/3151 sensor in an environment where the humidity is less than 30%RH, the measurements may sometimes fluctuate. This is not abnormal.

Product Specifications (EU Model)

| | RTR-576 | | RTR-576-S | |
|---|--|-------------------------|--|---------------------------------------|
| Temperature-Humidity Sensor | | | | |
| Temperature - 0Humidity Sensor (External) | THA-3001 | | SHA-3151 (High-Precision Type) | |
| | Thermistor | Polymer Resistance | Thermistor | Polymer Resistance |
| Measurement Channels | Temperature 1ch | Humidity 1ch | Temperature 1ch | Humidity 1ch |
| Measurement Units | °C, °F | %RH | °C, °F | %RH |
| Measurement Range (*1) | 0 to 55 °C | 10 to 95 %RH | -25 to 70 °C | 0 to 99 %RH (*2) |
| Accuracy | ±0.5 °C | ±5 %RH at 25 °C, 50 %RH | ±0.3°C at 10 to 40 °C ±0.5°C all other temperatures | ±2.5 %RH at 15 to 35 °C, 30 to 80 %RH |
| Measurement Resolution | 0.1 °C | 1 %RH | 0.1 °C | 0.1 %RH |
| Responsiveness | Response Time (90%): Approx. 7 min. | | Response Time (90%): Approx. 7 min. | |
| CO2 Sensor (Internal) | | | | |
| CO2 Sensor (Internal) | NDIR | | | |
| Measurement Channels | CO2 Concentration 1ch | | | |
| Measurement Units | ppm | | | |
| Measurement Range | 0 to 9,999 ppm | | | |
| Accuracy | ±(50 ppm + 5 % of reading) at 5,000 ppm or less (*3) | | | |
| Measurement Resolution | Minimum of 1 ppm | | | |
| Responsiveness | Response Time (90%): Approx. 1 min. | | | |
| Logging Capacity | 8,000 data sets (One data set consists of readings for all channels in that type of unit) | | | |
| Recording Interval | Select from 15 choices: 1, 2, 5, 10, 15, 20, 30 sec. or 1, 2, 5, 10, 15, 20, 30, 60 min. | | | |
| Recording Mode (*4) | Endless (Overwrite oldest data when capacity is full) or One Time (Stop recording when capacity is full) | | | |
| Communication Interfaces | Short Range Wireless Communication Frequency Range: 869.7 to 870MHz RF Power: 5mW Transmission Range: About 150 meters if unobstructed and direct USB 2.0 (Mini-B connector) | | | |
| External Alarm Terminal (*5) | Output Terminal: Open Drain Output (Voltage when OFF: DC less than 30V / Current when ON: less than 0.1A / Resistance when ON: about 15Ω) | | | |
| Power | AC Adaptor AD-06C1, AA Alkaline Battery LR6 x 4 | | | |
| Battery Life (*6) | Approx. 2 days (batteries only without AC adaptor) | | | |
| Dimensions | H 96 mm x W 66 mm x D 46 mm (excluding protrusions and sensor) Antenna Length: 60 mm | | | |
| Weight | Approx. 125 g | | | |
| Operating Environment | Temperature: 0 to 45 °C Humidity: 90 %RH or less (no condensation) | | | |
| Compatible Base Units | RTR500BW, RTR500BM, RTR500BC Other devices (*7) | | | |

*1: Make sure to use the data logger within the operating environment as listed in the specifications.

*2: When continually used in environments with temperatures above 60 °C, accuracy of humidity measurements will decrease over time. Also, humidity cannot be measured at temperatures below -20 °C.

*3: Stated value is the measurement accuracy of the CO2 sensor when Auto Calibration is operating properly. A change in atmospheric pressure directly influences the reading of CO2, which can cause measurement errors; a decrease in pressure by 10hPa results in a relative decrease in CO2 by 1.6 %. In such a case, we recommend carrying out the "Atmospheric Pressure Correction" function found in the software for the Base Unit.

*4: Only "Endless" is available when using the RTR500BW, RTR500BM, RTR-500NW/AW or RTR-500MBS-A as a Base Unit.

*5: In order to use the external alarm terminal, please purchase the optional alarm connection cable (AC0101).

*6: The listed battery life is based on the following usage conditions: Recording at 10 second (or longer) intervals, Current Readings Transmission every 10 minutes, and Recorded Data Transmission once a day. Battery life also varies depending on ambient temperature, radio environment, frequency of communication, etc.

*7: Also compatible with the following discontinued products: RTR-500DC, RTR-500, RTR-500NW/AW, RTR-500MBS-A

The specifications listed above are subject to change without notice.

Initial Settings

| | |
|----------------------|--|
| Recording Conditions | Recording Mode: Endless Recording Interval: 10 min. |
| LCD Display Pattern | Alternating Display |

Explanation of Symbols

Explanation of Warning Symbols

| | | |
|--|----------------|---|
| | DANGER | These entries are actions that, if taken, may cause serious personal physical damage or death. |
| | CAUTION | These entries are actions that if taken may lead to physical injury or damage to persons or things. |

Explanation of Picture Symbols

| | | | | | |
|--|--|--|-----------------------------|--|---|
| | Denotes an important warning or caution. | | Denotes a forbidden action. | | Denotes an action that should be carried out. |
|--|--|--|-----------------------------|--|---|

DANGER To Prevent Serious Accidents

- Do not disassemble, repair or modify the unit and accessories.
- Do not use the unit in any environment that is exposed to chemicals and harmful gases. Doing so may cause corrosion and/or other danger to the unit. Also, coming in contact with hazardous substances may cause bodily harm to the user or people nearby.
-
- This Unit is not waterproof. If water or a foreign object enters the case, immediately remove batteries and stop using it.
-
- Do not insert or replace batteries or sensors with wet hands.
-
- This unit has been designed for private and/or industrial use only. It should not be used in situations where strict safety precautions are necessary such as with medical equipment, or in systems directly or indirectly connected with human life or well-being.
-
- We shall not guarantee the unit's operation if it has been connected to a PC using a USB hub or a USB extension cable.
-
- Do not drop or expose the unit to a strong impact.
-
- Do not cut or process the sensor cables. Also, do not twist, pull on or swing any of the cords.
-
- To prevent damage to the unit from static electricity, remove static electricity from your body by touching metal around you (such as a door knob and window frame) before touching the unit.
-
- Place and store the unit and accessories out of the reach of children.
-
- Further, T&D is not responsible for any damage, malfunction or trouble, whether direct or indirect, caused by the use of our products.
-
- Do not use any power or sensors other than those specified by T&D Corporation.
-
- If the unit produces heat, emits smoke or a strange smell, or makes unusual noise, immediately unplug the AC adaptor, remove the batteries, and stop using it.

CAUTION Do not place or store in the following areas:

- Areas exposed to direct sunlight
- Areas subject to high temperatures such as near fire or heating equipment
- Areas exposed to static electricity
- Areas exposed to strong magnetic fields
- Areas exposed to dampness
- Areas subject to condensation or wet areas
- Areas exposed to excessive vibration
- Areas exposed to excessive smoke, dust or dirt.

CAUTION Other Precautions

- Use the unit in the specified operating environment. Do not use it for any purpose other than for which it was designed.
- Condensation may occur inside the case when a unit is moved from one environment to another where there is a great difference in temperature. Be careful to avoid condensation.
- Do not use the unit in wet areas or places exposed to water such as bathroom.
- Do not insert any foreign objects into any of the units' jacks.
- If the unit gets dirty, wipe it with a clean cloth.
- Please note that this User's Manual has been written based on the presupposition that details about set-up of any necessary equipment to enable network connection have already been taken care of by the user and that connection has been confirmed as workable. T&D Corporation shall not be responsible for any damages which a contractor, a user or a third party may suffer, whether direct or indirect, due to the inability to communicate or use communication devices.

CAUTION Notes and Precautions for Installing Wireless Communication Devices

- When installing wireless communication devices take special care in selecting locations so as to ensure proper communication. Note that even after a successful installation, due to changes in environmental conditions, communication errors may occur when restarting the system.
- As far as possible, try to keep wireless communication devices away from metals and set them up in high unobstructed positions.
 - Please take note that in many instances, walls, floors, stairs, fences and desks will contain metals. In order to carry out communication between indoor and outdoor units, please locate indoor units near a window so that radio waves can be easily transmitted.

- Please install the Unit more than 30 cm away from walls or boards containing metal.
- If the Unit is placed in a metal container such as a freezer or refrigerator, the possible wireless communication range will be shortened. In most cases radio waves are transmitted via doors and door openings so place the Unit as near to doors as possible.
- As far as possible, keep the Unit away from noise-emitting sources.
- Equipment such as some industrial instruments, electronic devices or fluorescent lamps generate noise. Please place the Unit more than 1 meter away from such devices.
- Please place the Unit more than 1 meter away from computers and other devices which emit noise.
- Keep all wires as far away from wireless communication devices as possible. Please be careful about placing near any wiring or cables such as power supply cables, telephone wires or LAN cables.
- Objects which contain lots of water, such as plants or soil, absorb radio waves. We highly recommend that such materials should not be placed between or near wireless communication units.
- When measuring temperature in a greenhouse it has been reported that as plants grow, communication errors also increased.
- Do not place the Unit directly on the ground.
- Do not place Units which are using the same communication frequency channel in the same area. If the same channel is used for multiple units not only will more communication errors occur, but battery life will also be shortened.
- If there is a possibility that Units with the same frequency channel will be in wireless communication at the same time, please make sure to make changes to the frequency channels so they are not the same.

Important Notices and Disclaimers

In order to properly use this product, please carefully read all documents that accompany the product before using.

- All rights of the attached documents belong to T&D Corporation. It is prohibited to use, duplicate and/or arrange a part or whole of the attached documents without the permission of T&D Corporation.
- Microsoft and Windows are registered trademarks of Microsoft Corporation in the United States and/or other countries.
- All registered trademarks, company names, product names and logos mentioned herein or for products being used are the property or registered property of T&D Corporation or of their respective owners.
- Specifications, design and other contents outlined in the attached documents are subject to change without notice.
- Please follow the safety precautions outlined in the attached documents carefully. We cannot guarantee nor are we responsible for safety if this product is used in any manner other than was intended.
- On-screen messages in the attached documents may vary slightly from the actual messages.
- Please notify the shop where you purchased this product or T&D Corporation of any mistakes, errors or unclear explanations in the attached documents. T&D Corporation accepts no responsibility for any damage or loss of income caused by the use of our product.
- Accompanying documents cannot be reissued, so please keep them in a safe place.
- Please read the warranty and provisions for free repair carefully.

Compliance Information

CE Statement

The RTR-500 Series products are in compliance with the Radio Equipment Directive 2014/53/EU.

The following standards have been applied:

<Safety and Health> EN 60950-1
EN 50663
<EMC> EN 301 489-1
EN 301 489-3
<Radio Spectrum> EN 300 220-2 (receiver category 2)

The full text of the EU declaration of conformity is available at the following internet address: <https://tannd.com/manual/pdf/doc-rtr500-series.pdf>

Important Notices

Wireless products cannot be used in countries other than where those products have been approved for use, according to that country's wireless regulations. T&D Corporation shall in no manner whatsoever take responsibility for the usage of these products, nor be liable in any manner for legal consequences stemming from the usage of these wireless products in unapproved areas.

For product information or questions contact us at:

T&D Corporation

817-1 Shimadachi Matsumoto, Nagano 390-0852 JAPAN
Fax: +81-263-40-3152 E-mail: support@tannd.com

<https://tannd.com/>

We have opened an English Website for your convenience. Here you can find information about our company, news, products, upcoming events, software and Introductory Manual downloads, as well as, their support. Please stop by and see what we have to offer.