



Illuminance UV Recorder WL RTR-574 / RTR-574-S

Introductory Manual

Thank you for purchasing our product.

Carefully read this instruction manual before using this Unit.



RTR-574 Package Contents

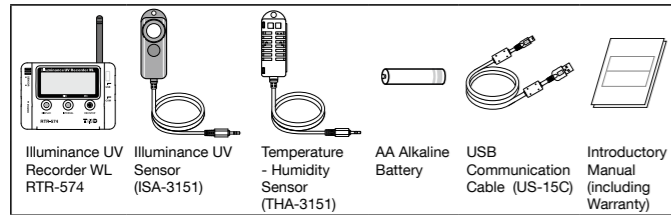

RTR-574-S Package Contents

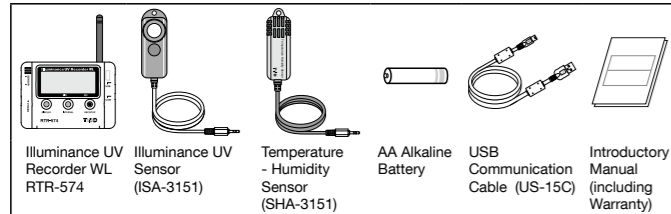

© Copyright T&D Corporation. All rights reserved. 2020.08 16504670043 (8th Edition)
This is printed using recycled paper.

Illuminance UV Recorder WL RTR-574 is a Data Logger, with built-in wireless communication capability, designed to measure and record Illuminance, UV Intensity, Temperature and Humidity at a set interval.

Recorded data can be downloaded from an RTR-574 Data Logger (Remote Unit) via wireless communication with a Base Unit; that data can then be viewed in a graph and/or saved to PC for analysis or sharing over a network.

As a Remote Unit, RTR-574 requires a Base Unit to carry out wireless communication. (Compatible Base Units: RTR-500, RTR-500NW, RTR-500AW, RTR-500DC, RTR-500MBS-A)

The RTR-574 can be operated with "RTR-500 for Windows" version 1.10 or later.

When you use "RTR-500 for Windows", please check the software version by selecting "Version Info" in the [Help] Menu. The latest version of the software can be downloaded from our T&D Web Site.

Before using an RTR-574, it is first necessary to install the USB Device Driver from the software that comes with the Base Unit.

Appearance Diagram and Part Names

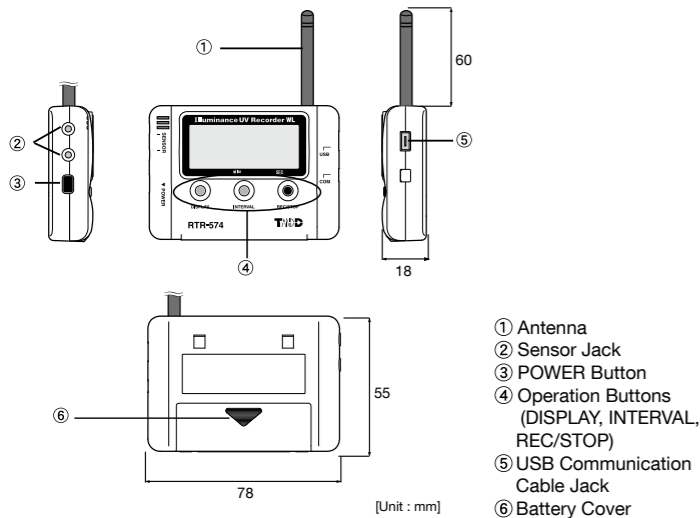

- ① Antenna
- ② Sensor Jack
- ③ POWER Button
- ④ Operation Buttons (DISPLAY, INTERVAL, REC/STOP)
- ⑤ USB Communication Cable Jack
- ⑥ Battery Cover

Reading the LCD Display

① REC Mark	The recording status is shown here. ON: Recording in progress. BLINKING: Waiting for programmed start. OFF: Recording has been stopped.
② DATA	The number of recorded readings is shown in a scale here. After every 2,000 readings the scale is marked from left to right. Storage capacity is 8,000 readings.
③ COM Mark	The communication status is shown here. ON: The Unit is connected to a PC with the USB cable. BLINKING: The Unit is in Wireless/USB/Serial communication.
④ Recording Mode	ENDLESS: Upon reaching storage capacity of 8,000 readings, the oldest data is overwritten and recording continues. ONETIME: Upon reaching storage capacity of 8,000 readings, recording will automatically stop.
⑤ Battery Life Warning Mark	When it is time for the battery to be replaced, this mark will appear. Not ON: Ample battery power. ON: Time to change the battery.
⑥ Current Readings / Messages Area	Normally, the current readings are shown here. Depending on the Unit's status, operational messages may also be displayed.
⑦ Unit of Measurement	Humidity: % , Temperature: °C / °F, Illuminance: lx, Klx Cumulative Illuminance: lxh, klxh, Mlxh UV Intensity: mW/cm ² , Cumulative Amount of UV Light: mW/cm ² h, W/cm ² h

From hereafter in this manual, Illuminance UV Recorder WL RTR-574 will be referred to as the "Unit".

Notices about this Manual

In order to properly use this product, please carefully read this manual before using.

- All rights of this Manual belong to T&D Corporation. It is prohibited to use, duplicate and / or arrange a part or whole of this Manual without the permission of T&D Corporation.
- "TANDD", "T&D" and the logo of T&D Corporation are all registered property of T&D Corporation.
- Specifications, design and other contents outlined in this manual are subject to change without notice.
- We are not responsible for any malfunction or trouble caused by the use of our product or by any problem caused by the use of measurement results of our unit. Please be fully aware of this before using our product.
- On screen messages in this manual may vary slightly from the actual messages.
- Please notify the shop where you purchased this product or T&D Corporation of any mistakes, errors or unclear explanations in this manual.
- T&D Corporation accepts no responsibility for any damage or loss of income caused by the use of our product.
- This product has been designed for private or industrial use only. It is not for use in situations where strict safety precautions are necessary such as in connection with medical equipment, whether directly or indirectly.
- This Manual cannot be reissued, so please keep it in a safe place.
- Please carefully read this Manual and Warranty.

Safety Precautions and Instructions * Please carefully observe the following safety measures when using our product.

To prevent any loss or damage to our customers, other people and/or property, and to ensure the proper use of our products we ask that before using our product you carefully read, understand and follow the safety rules and precautions for our products as outlined below.

Explanation of Warning Symbols	Explanation of Picture Symbols
DANGER These entries are actions that absolutely under no circumstance should be taken. The taking of such an action may cause serious personal physical damage or death.	Denotes an important warning or caution.
CAUTION These entries are actions that if taken may lead to physical injury or damage to persons or things.	Denotes a forbidden action.
	Denotes an action that must be taken.

- DANGER**
- Do not take apart, repair or modify the Unit. Touching them may result in malfunction or unexpected accidents.
- If water or a foreign object enters into the Unit, immediately turn OFF the power, remove batteries, and stop using. Continued use may cause fire or electrocution.
- Do not use this Unit in wet or humid places, such as a bathroom. It may cause a fire or other trouble including malfunction.
- If water or a foreign object enters the case, immediately cease using it.
- Store the Unit and accessories out of the reach of children. Touching them may result in unexpected accidents.
- If any smoke or strange smells are emitted from the Unit, immediately turn OFF the power, remove batteries, and stop using. Continued use may cause fire or electrocution.
- Do not drop the Unit, or expose the Unit to a strong impact. If that happens to the Unit, immediately turn OFF the power, remove batteries, and stop using. Continued use may cause fire or electrocution.
- When installing and using this product, make sure to follow all warnings and directions from your computer manufacturer.

- CAUTION**
- This Unit is not waterproof. If the Unit gets dirty, wipe it with a clean cloth.
- Harmful gases or chemicals may cause corrosion and/or other danger to the Unit. Also, by coming in contact with hazardous substances, harm may occur to the people handling the Unit. Therefore, do not use or store the Unit in any environment that is exposed to chemicals and harmful gases.
- Battery life varies depending upon the type of battery, the battery performance, the measuring environment, and the frequency of communication.
- Battery terminals may provide insufficient contact due to age or vibration. This may lead to data loss.

- Use the Unit in an environment within the operational range.
- Condensation may occur when a Unit is moved from one environment to another where there is a great difference in temperature.
- To prevent damage to the Unit from static electricity, remove static electricity from your body by touching metal around you (door knob, window frame) before touching the Unit. Static electricity may cause not only damage to the Unit, but may cause breaks in or a loss of data.
- If the Unit is not to be used for a long period of time, for safety reasons please remove the battery. If left in the Unit, it may leak and lead to malfunctioning. Please use a new battery when you use the Unit again.
- Do not store or leave the Unit in any place exposed to high temperature and high humidity. If the Unit is not to be used for a long period of time, store it in a place with a normal temperature and without condensation with other items included.
- Do not disconnect the communication cable during USB communication. This may harmfully effect the Unit or your PC.
- We shall not guarantee the operation of our device if you have connected it to your computer using a USB hub or a USB extension cable.
- Please do not insert your fingers or any foreign objects into the sensor or USB connection jacks.
- Do not use or store the Unit in any of the following places. Doing so may cause electrocution, fire and/or other adverse effects to the device and/or your computer.
 - Areas exposed to direct sunlight
This will cause the inside of the Unit to become overheated and may cause fire, deformation, and/or other damage including malfunction.
 - Areas prone to strong magnetic fields
This may cause damage including malfunction.
 - Areas exposed to water leakage
This may cause electrocution or other damage including malfunction.
 - Areas exposed to excessive vibration
This may cause injury, malfunction, damage or loss of proper electrical contact.
 - Areas near fire or exposed to excessive heat
This may cause damage including malfunction and deformation.
 - Areas prone to dust and dirt
This may cause damage including malfunction.

⚠ Cautions about using the Illuminance UV Sensors

- Do not connect the ISA-3151 sensor to any data logger other than those specified by T&D Corporation.
- Use the Unit in an environment within the operational range.
- When measuring UV light or other light which may cause damage or injury to your eyes or skin make sure to use protection such as safety glasses or some type of light-proof shield.
- Do not expose the sensor to a strong impact. Cracks or scratches in the illuminance sensor and / or in the UV sensor will adversely affect the measurement accuracy. Also, a broken sensor may result in injury.
- This sensor is not waterproof. By all means do not allow it to get wet.
- Do not expose to condensation, dampness, corrosive gases or organic solvents. Also, do not use in areas near fire or exposed to excessive heat.
- When the Illuminance UV sensor is not being used, please store at room temperature to prevent condensation.
- If the sensor surface gets dirty, wipe it with a soft cloth. If the sensor surface accumulates impurities (dirt), it will cause a decrease in the sensor's accuracy and sensitivity.
- If you wish to extend the length of the sensor cable, please purchase and use our optional sensor extension cable (TR-1C30 / TR-5C10). Do not cut or process the sensor cables.
- Using the "Adjustment Function" in the software supplied with the Base Unit, it is possible to make desired adjustment settings to a sensor; these settings are saved directly into the sensor itself. Therefore, when a sensor is replaced, it is necessary to re-make any desired adjustment settings to be saved into the newly connected sensor.

⚠ Cautions about using the Temperature-Humidity Sensors

- Do not connect the THA-3001/3151 sensor to any data logger other than those specified by T&D Corporation.
- Use the Unit in an environment within the operational range.
- When using the THA-3001/3151 sensor in an environment where the humidity is less than 30%RH, the measurements may sometimes fluctuate. This is not abnormal.
- If extremely severe temperature changes occur, the humidity measurements may appear abnormal. Once the sensor's temperature becomes stable, the measurements will return to normal.
- This sensor is not waterproof. Only use in an environment where there is no condensation or possibility of becoming wet. Do not use in water or near areas where high-pressure water is flowing.
- Do not expose to condensation, dampness, corrosive gases, or organic solvents.
- When the sensor is not to be used for a long period of time, please store it at normal temperature and humidity.
- During use, the surface of the temperature - humidity sensor will accumulate impurities (dirt) causing a decrease in the sensor's accuracy and sensitivity. If the sensor is being used in an environment where smoke and dust are in abundance, periodic calibration may be required.
- Do not use this sensor on a human body.
- If you wish to extend the length of the sensor cable, please purchase and use our optional sensor extension cable (TR-1C30 / TR-5C10). Do not cut or process the sensor cables.
- Using the "Adjustment Function" in the software supplied with the Base Unit, it is possible to make desired adjustment settings to a sensor; these settings are saved directly into the sensor itself. Therefore, when a sensor is replaced, it is necessary to re-make any desired adjustment settings to be saved into the newly connected sensor.

⚠ Wireless Regulations

CE Statement
The RTR-500 Series products are in compliance with the Radio Equipment Directive 2014/53/EU.
The following standards have been applied:
<Safety and Health> EN 60950-1
EN 50663
<EMC> EN 301 489-1
EN 301 489-3
<Radio Spectrum> EN 300 220-2 (receiver category 2)
The full text of the EU declaration of conformity is available at the following internet address:
http://cdn.tandd.co.jp/glb/manual/DoC_RTR500_Series.pdf

⚠ Important Notice

Wireless products cannot be used in countries other than where those products have been approved for use, according to that country's wireless regulations.
T&D Corporation shall in no manner whatsoever take responsibility for the usage of these products, nor be liable in any manner for legal consequences stemming from the usage of these wireless products in unapproved areas.

Getting the RTR-574 (Remote Unit) Ready to Use

1. Please get the Base Unit ready first before the RTR-574 (Remote Unit).

1. Install the Battery.

Remove the battery cover and insert the battery, making sure that the + and - are in the correct direction.

Be sure to completely close the cover.

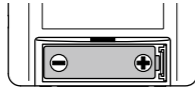

2. Connect the included Sensors.

The Sensor Jacks are common for both sensors. The Temperature - Humidity Sensor and the Illuminance UV Sensor can be connected to either jack.

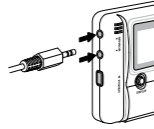

3. Turn ON the Power.

Press the POWER button until the LCD display appears.

4. Register the Remote Unit by using the software supplied with the Base Unit.

When the direction appears in the software window, connect the Unit to the computer. For details about settings and functions of the software, please see the [Help] Menu in that software.

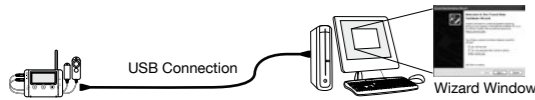
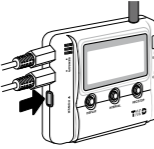

If upon USB connection, the [New Hardware Detection Wizard] opens, it is necessary to follow directions to install the USB Device Driver.

- If you have not installed the Software supplied with the Base Unit, please close the Wizard Window and disconnect the USB cable from your PC.
- For details see the Introductory Manual that came with your Base Unit.

Battery Replacement Mark and Message

When it is time for the battery to be replaced, a battery life warning mark will appear. While this mark is on display, wireless communication may be broken or may be impossible.



If you change the battery while the mark is displayed, recording will continue uninterrupted.

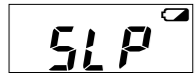

If the battery is not changed, but remains in use, [SLP] will appear in the LCD display. Recording will stop in order to protect recorded data until this point.

- Recording will not be resumed even if the battery is changed at this point.



If the battery is further left unchanged, the display will automatically shut off. All of the recorded data up until that point will be erased.

- If + (plus) and - (minus) are mistaken, or if the battery terminals + and - are shorted, the recorded data that is stored in the Unit will be lost.
- If the Unit is left without a battery for some time, all data may be lost, so please work quickly when changing the battery.

Other Messages



FULL (Storage Capacity FULL)

When Recording Mode has been set to "ONETIME" and the Unit reaches its storage capacity of 8,000 readings, recording will automatically stop and in the LCD the current measurement and the word "FULL" will alternately appear.



Sensor Unconnected

This will be displayed when a sensor has not been connected or the wire has been broken.

- Measurement and recording will continue so battery power will be consumed.
- If after re-connecting the sensor and measurements can still not be displayed, it is very possible that the sensor or the Unit are defective or have been damaged.

Button Operation

1. If no operations can be performed using buttons on the Unit, it means the buttons have been de-activated via the software supplied with the Base Unit.

POWER Button

Use this button to turn ON/OFF the Power.

ON: Press the POWER button.

OFF: Press the POWER button until the LCD displays "OFF".

- During recording, the power cannot be turned off by pressing the POWER button on the Unit. Please stop recording first and then turn off the power.
- If there is ample battery power remaining in the Unit, even if the power has been turned off, the recorded data will be saved.

DISPLAY Button

Use this button to change the LCD Display Pattern.

There are two LCD display patterns for readings: An Alternate Display and a Fixed Display.

The factory default setting is an Alternate Display between Illuminance and UV Intensity.

With each pressing of the button the measurement items will be shown alternately in the following order for a Fixed Display:

→ Illuminance (lx, Klx) → UV Intensity (mW/cm²) → Temperature (°C, °F) → Humidity (%) → Cumulative Illuminance (lxh, Klxh, Mlxh) → Cumulative Amount of UV Light (mW/cm²h, W/cm²h) → Back to the Alternate Display
When the desired measurement item for a Fixed Display appears, stop pressing the button.

Alternate Display:

The LCD display shows all or selected multiple measurement items in turn.

- Make settings for the measurement items to be displayed via the software supplied with your Base Unit.

Fixed Display:

The LCD display shows one measurement item specified by pressing the DISPLAY button.

Cumulative Illuminance and Cumulative Amount of UV Light

Cumulative Illuminance and Cumulative Amount of UV Light are the numerical values obtained by accumulating measurement readings from recording start until stop. The timing of accumulation will be the same as when the display is refreshed.

INTERVAL Button

Use this button to check and change Recording Interval Setting.

The factory default setting for the recording interval is 10 minutes.

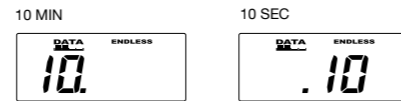

Checking the Recording Interval:

By holding the INTERVAL button down, the currently set recording interval will appear on the LCD display.

- If no operation is carried out after the recording interval has been displayed, the current measurement readings will return to the LCD display.

Changing the Recording Interval:

With each pressing of the button while the recording interval is on display, the interval time will change as follows:

1, 2, 5, 10, 15, 20 and 30 seconds / 1, 2, 5, 10, 15, 20, 30 and 60 minutes

When the desired recording interval appears, stop pressing the button.

- Changes can only be made when recording has been stopped.

REC/STOP Button

Use this button to Start and Stop Recording.

1. By starting a new recording session, all data currently saved in the Unit will be erased.

Start Recording:

Press the REC/STOP button until the [REC] mark appears on the display.



Stop Recording:

Press the REC/STOP button until the [REC] mark disappears from the display to stop recording.

- Make settings for the recording mode (ENDLESS / ONETIME) via the software supplied with the Base Unit.
- It is possible to start recording even if the Unit is waiting for a programmed recording to start. All programming is done via the software which comes with the Base Unit.

Relative Spectral Response Characteristics Graph (Illuminance)

Broken line: the CIE standard response function V (λ)
Solid line: ISA-3151

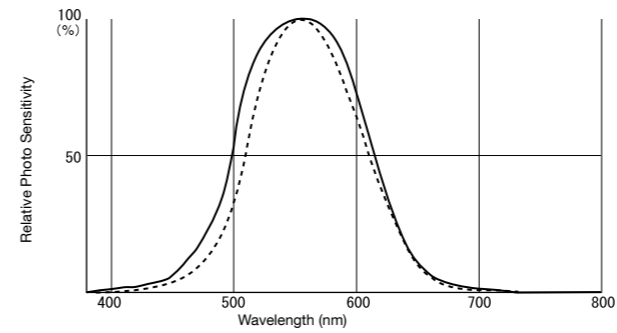

Relative Spectral Response Characteristics Graph (UV)

ISA-3151

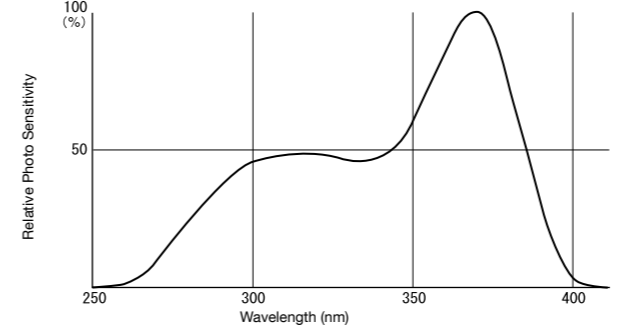

Cosine Correction Characteristics (Illuminance)

Broken line: cos θ
Solid line: Measurement Value

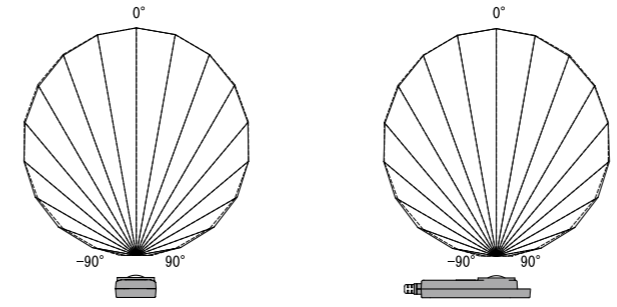

Cosine Correction Characteristics (UV)

Broken line: cos θ
Solid line: Measurement Values

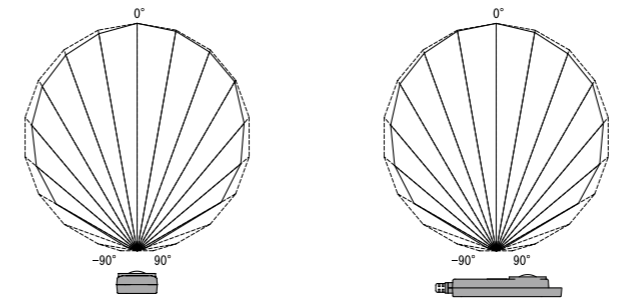

Options

TR-1C30: Sensor Extension Cable

Temperature Durability: -25 to 60°C

Cable Length: 3 m

Up to 3 extension cables can be connected to one sensor

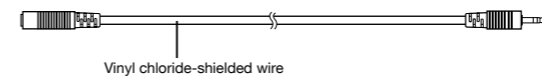

TR-6C10: Serial Communication Cable

For communication between RTR-500DC and RTR-574

Cable Length: 1 m

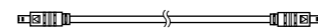

Specifications

Product	RTR-574		RTR-574-S	
	THA-3151		SHA-3151 (High-Precision Type)	
Temperature - Humidity Sensor (External)	Thermistor	Polymer Resistance	Thermistor	Polymer Resistance
Measurement Channels	Temperature 1ch	Humidity 1ch	Temperature 1ch	Humidity 1ch
Units of Measurement	°C, °F	%RH	°C, °F	%RH
Measurement Range	0 to 55 °C	10 to 95 %RH	-25 to 70 °C	0 to 99 %RH (*1)
Accuracy	±0.5 °C	±5 %RH at 25 °C, 50 %RH	±0.3 °C at 10 to 40 °C ±0.5 °C all other temperatures	±2.5 %RH at 15 to 35 °C, 30 to 80 %RH
Measurement Resolution	0.1 °C	1 %RH	0.1 °C	0.1 %RH
Responsiveness	Response Time (90%): Approx. 7 min.		Response Time (90%): Approx. 7 min.	

Illuminance/UV Sensor (External)	ISA-3151
Measurement Channels	Illuminance: 1ch UV Intensity: 1ch
Units of Measurement	Illuminance: lx, klx UV Intensity: mW/cm ²
Measurement Range	Illuminance: 0 lx to 130 klx UV Intensity: 0 to 30 mW/cm ²
Units of Cumulative Measurement	Cumulative Illuminance: lxh, klxh, Mlxh Cumulative amount of UV Light: mW/cm ² h, W/cm ² h
Display Range of Cumulative Measurement	Illuminance: 0 lxh to 90 Mlxh UV Intensity: 0 mW to 62 W/cm ² h
Accuracy	Illuminance 10 lx to 100 klx : ±5 % at 25 °C, 50 %RH UV Intensity 0.1 to 30 mW/cm ² : ±5 % at 25 °C, 50 %RH (*2)
Relative Spectral Response	Illuminance: Approximated to the CIE standard response function V (λ) UV Intensity: 260 to 400 nm (UVA/UVB)
Measurement Resolution	Illuminance: Minimum of 0.01 lx UV Intensity: Minimum of 0.001 mW/cm ²
Responsiveness	Response Time (90%): 3 sec. at recording interval of 1 sec. or 6 sec. at other intervals

Logging Capacity	8,000 data sets (One data set consists of readings for all channels in that type of unit.)
Recording Interval	Select from 15 choices: 1, 2, 5, 10, 15, 20, 30 sec. or 1, 2, 5, 10, 15, 20, 30, 60 min.
Recording Mode (*3)	Endless (Overwrite oldest data when capacity is full) or One Time (Stop recording when capacity is full)
Communication Interfaces	Short Range Wireless Communication ETSI EN 300 220 Frequency Range: 869.7 to 870MHz, RF Power: 5mW USB Communication Serial Communication: RS-232C (*4)
Wireless Transmission Range	Approx. 150 meters (500 ft) if direct and unobstructed
Power	AA Alkaline Battery LR6 x 1
Battery Life (*5)	Approx. 4 months
Dimensions	H 55 mm x W 78 mm x D 18 mm (excluding protrusions) Antenna Length: 60 mm
Weight	Approx. 45 g
Operating Environment	Temperature: -10 to 60 °C Humidity: 90 %RH or less (no condensation)
Compatible Base Units	RTR-500, RTR-500NW/500AW, RTR-500DC, RTR-500MBS-A

*1: When continually used in environments with temperatures above 60°C, accuracy of humidity measurements will decrease over time. Also, humidity cannot be measured at temperatures below -20°C.

*2: Compared to the value measured by the T&D standard sensor for calibration under our calibration light source.

*3: Only "Endless" is available when using RTR-500W for Windows or RTR-500MBS for Windows.

*4: For communication with the Data Collector RTR-500DC (Note: Optional serial communication cable TR-6C10 is required.)

*5: Battery life varies depending upon multiple factors including ambient temperature, recording interval, frequency of communication, and battery performance. All estimates are based on operations carried out with a new battery and are in no way a guarantee of actual battery life.

The specifications listed above are subject to change without notice.

TR-07K2: Wall Attachment

Included: Screw x 2 and Double-sided Tape x 1

Materials: Polycarbonate

