

## **Mobile Base Station RTR-500GSM**

---

### **Introductory Manual**

Thank you for purchasing our product. This manual provides a brief explanation of how to set up and get started with the RTR-500GSM.

Details about how to use the software "RTR-500GSM for Windows" and its functions can be found in the Software "Operation Guide (Help)".



# Table of Contents

---

## Introduction

Notices .....	2
Software User Agreement .....	3
Safety Precautions and Instructions .....	4
Notes and Precautions for Installing Wireless Communication Devices .....	9
Wireless Regulations .....	10
Important Notice .....	10
Note about SIM Cards .....	11

## What are Base Units, Remote Units and Repeaters? .....

Features of RTR-500GSM .....	13
Basic Procedures .....	14

## Getting Ready

Package Contents .....	16
About SIM Cards .....	16
RTR-500GSM Appearance Diagrams and Part Names .....	17
Getting the RTR-500GSM Ready to Use .....	18
About the Operation Switch .....	21

## Installing the Software and the USB Device Driver

Before Installing the Software .....	24
Before Installing the Software .....	24
RTR-500GSM for Windows Installation Procedure .....	25
Installing the USB Device Driver .....	27
USB Driver for Windows XP .....	28

## Other

About Applications and the Operation Guide .....	30
How to Open .....	30
Operation Guide: .....	30
Other Items .....	30
RTR-500GSM Initial Settings .....	31
Remote Units and Repeaters .....	32
Connecting a Remote Unit (Optical Communication) .....	32
Connecting a Repeater .....	32
External Parts .....	33
About the External Contact Output / Input Connector .....	33
About External Power Sources .....	33
LED Display .....	34
Tips for Placing the RTR-500GSM .....	35
FAQ's .....	36
Q&A about RTR-500GSM .....	36
Q&A about SIM Cards and GSM .....	37
Product Specifications .....	38
RTR-500GSM .....	38
Software (RTR-500GSM for Windows) .....	40
Options .....	41
RTR-500GSM Warranty .....	Back

## Notices

Carefully read this manual so that you can properly use this product.

T&D Corporation accepts no responsibility for any malfunction of and/or trouble with this product or with your computer that is caused by the improper handling of this product and will deem such trouble or malfunction as falling outside the conditions for free repair of the attached warranty.

- All rights of this Introductory Manual belong to T&D Corporation. It is prohibited to use, duplicate and/or arrange a part or whole of this Introductory Manual without the permission of T&D Corporation.
- Microsoft ® and Windows ® are registered trademarks of Microsoft Corporation USA and are binding in the USA and all other countries.
- Company names and product names are trademarks or registered trademarks of each company.
- GSM is a trademark of GSM MOU Association.
- Specifications, design and other contents are subject to change without notice.
- On screen messages in this manual may vary slightly from the actual messages.
- Please notify the shop where you purchased this product or T&D Corporation of any mistakes, errors or unclear explanations in this manual. T&D Corporation accepts no responsibility for any damage or loss of income caused by the use of our product.
- This product has been designed for private or industrial use only. It is not for use in situations where strict safety precautions are necessary such as in connection with medical equipment, whether directly or indirectly.
- We are not responsible for any malfunction or trouble caused by the use of our product or by any problem caused by the use of measurement results of our Unit. Please be fully aware of this before using our product.
- Some of our products, which come under the category of strategic goods in foreign trade law, need the permission of the Japanese government to be exported outside of Japan.
- The Manual itself can be downloaded from our Website:  
<http://www.tandd.com/>

## Software User Agreement

### Disclaimers

- T&D Corporation does not guarantee the operation of RTR-500GSM for Windows.
- T&D Corporation shall not accept any responsibility for any damage, whether direct or indirect, that results from the usage of RTR-500GSM for Windows.
- Specifications of RTR-500GSM for Windows may be subject to change and service may be terminated without advance notice to the user. In such a case, T&D Corporation shall not be responsible for any damages, whether direct or indirect, from the inability to use RTR-500GSM for Windows.
- T&D Corporation has no obligation to correct any defects found in RTR-500GSM for Windows.

### Copyright

- The Copyright for RTR-500GSM for Windows, including the program and relevant documents, belongs solely to T&D Corporation.
- The reprinting or redistribution for commercial purposes whether in part or in whole, in magazines or as a part of any product is strictly forbidden without the expressed consent of T&D Corporation. Any inquires concerning commercial redistribution should be directed to the Sales Department of T&D Corporation.
- Please do not attempt to make any changes or modifications to RTR-500GSM for Windows.



# Safety Precautions and Instructions

---



Before using please read the following precautions and instructions. The following items should be strictly obeyed for the safe usage of the Unit, and for protecting yourself and other people from bodily harm and/or damage to property.

## Explanation of Symbols

### Explanation of Warning Symbols

 <b>DANGER</b>	These entries are actions that absolutely under no circumstance should be taken. The taking of such an action may cause serious personal physical damage or death.
 <b>CAUTION</b>	These entries are actions that if taken may lead to physical injury or damage to persons or things.

### Explanation of Picture Symbols

	Denotes a forbidden action.
	Denotes a forbidden action. Inside or near the symbol will appear another symbol giving details.
	Denotes an action that you must take.

 **DANGER**

 Power must be turned off before entering, and the Unit not used in any of the following places:

Areas where explosive gas may be present including gas stations  
This may cause a fire or explosion.

Areas where the use of the Unit has been prohibited including aircraft and hospitals, as the Unit may transmit signals that could interfere with aircraft or medical equipment.

---

 Be sure to follow the warnings and notices about use from your PC maker when installing and using the Unit.

---

 Do not take apart, repair or modify the Unit.  
Doing so may cause fire or electrocution.

---

 If water or a foreign body enters the Unit, immediately disconnect the cables from the Unit, remove batteries, and stop using.  
Continued use may cause fire or electrocution.

---

 Do not use the Unit in wet or humid places, such as a bathroom.  
It may cause a fire or other trouble including malfunction.

---

 Store main Unit, batteries, SIM card and communication cables out of the reach of children.  
It is dangerous to touch or swallow them.

---

 Do not connect the communication cable to a telephone line.  
It may cause a fire or other trouble including malfunction.

---

 If any smoke or strange smells are emitted from the Unit, immediately disconnect the cables from the Unit, remove batteries, and stop using.  
Continued use may cause fire or electrocution.

---

 Do not drop the Unit, or expose the Unit to a strong impact. If that happens to the Unit, immediately disconnect the cables from the Unit, remove batteries, and stop using.  
Continued use may cause fire or electrocution.

---



Make sure to periodically remove dust and dirt from the AC adaptor plug.

If dust is allowed to accumulate on the plug, moisture may cause poor insulation and result in fire.



Do not unplug the AC adaptor with wet hands.

This may cause electrocution.

---



 **CAUTION**

 This product has been designed for private or industrial use only. It is not for use in situations where strict safety precautions are necessary such as in connection with medical equipment, whether directly or indirectly.

---

 Harmful gases or chemicals may cause corrosion and/or other danger to the Unit. Also, by coming in contact with hazardous substances, harm may occur to the people handling the Unit. Therefore, do not use in any environment that is exposed to chemicals and harmful gases.

---

 The Unit is not water-resistant.  
If the Unit gets dirty, wipe it with a clean cloth and a mild detergent.

---

 Please do not insert your fingers or any foreign objects into any of the devices' jacks.

---

 Make sure that the cable and AC adaptor are inserted fully, so as not to cause an improper connection. Also, when unplugging the cable from the Unit, do not pull the cord, but hold the connector to disconnect.

---

 Battery life depends on the measurement environment, communication frequency, recording interval and battery quality.

---

 Do not use any other batteries and AC adaptor than those that are specified in this Introductory Manual.  
It may cause a fire or other trouble including malfunction.

---

 Do not put anything on top of the AC adaptor.  
This may cause overheating.

---

 Remove batteries from any Unit that is not to be used for a long period of time.  
Batteries left in a Unit not being used for a long time may leak and cause a malfunction.

---

 Battery terminals may provide insufficient contact due to age or vibration.  
This may lead to data loss.

---

 Condensation may occur if the Unit is moved from one environment to another where the difference in temperature is great.  
Use the Unit in an environment where the ambient temperature is from 10 to 55 °C and the humidity is 20 to 80%RH (no condensation) or less.

---



To prevent damage to the Unit from static electricity, remove static electricity from your body by touching metal around you (door knob, window frame) before touching the Unit.

Static electricity may cause not only damage to the Unit, but may cause breaks in or a loss of data.

---



Please take extra caution when plugging in and pulling out the USB plug while another USB device such as CDD/HDD is in operation. It may cause problems to your CD-RW or other device.

We shall not guarantee the operation of our device if you have connected it to your computer using a USB hub or a USB extension cable.

---



Do not use or store the Unit in any of the following places. Doing so may cause electrocution, fire and/or other adverse effects to the device and/or your computer.

- Areas exposed to direct sunlight.

This will cause the inside of the device to become overheated and may cause fire, deformation, and/or other damage including malfunction.

- Areas prone to strong magnetic fields.

This may cause damage including malfunction.

- Areas exposed to water leakage.

This may cause electrocution or other damage including malfunction.

- Areas exposed to static electricity.

This may cause damage including malfunction.

- Areas exposed to excessive vibration.

This may cause injury, malfunction, damage or loss of proper electrical contact.

- Areas that are not flat or level.

This may cause the Unit to fall and result in injury and/or damage.

- Areas near fire or exposed to excessive heat.

This may cause damage including malfunction and deformation.

- Areas prone to smoke, dust and dirt.

This may cause damage including malfunction.

---



## Notes and Precautions for Installing Wireless Communication Devices

When installing wireless communication devices take special care in selecting locations so as to ensure proper communication.

Note that even after a successful installation, due to changes in environmental conditions, communication errors may occur when restarting the system.

As far as possible, try to keep wireless communication devices away from metals and set them up in high unobstructed positions.

- Please take note that in many instances, walls, floors, stairs, fences and desks will contain metals. In order to carry out communication between indoor and outdoor Units, please locate indoor Units near a window so that radio waves can be easily transmitted.
- Please install these devices more than 30cm away from walls or boards containing metal.
- If wireless communication Units are placed in a metal container such as a freezer or refrigerator, the possible wireless communication range will be shortened. In most cases radio waves are transmitted via doors and door openings so place devices as near to doors as possible.

As far as possible, keep the devices away from noise-emitting sources.

- Equipment such as some industrial instruments, electronic devices or fluorescent lamps generate noise. Please place Units more than 1 meter away from such devices.
- Please place Units more than 1 meter away from computers and other devices which emit noise.
- Keep all wires as far away from wireless communication devices as possible. Please be careful about placing near any wiring or cables such as power supply cables, telephone wires or LAN cables.

Objects which contain lots of water, such as plants or soil, absorb radio waves. We highly recommend that such materials should not be placed between or near wireless communication Units.

- When measuring temperature in a greenhouse it has been reported that as plants grew, communication errors also increased.
- Do not place Units directly on the ground.

Do not place devices which are using the same communication frequency channel in the same area.

- If the same channel is used for multiple devices not only will more communication errors occur, but battery life will also be shortened.
- If there is a possibility that devices with the same frequency channel will be in wireless communication at the same time, please make sure to make changes to the frequency channels so they are not the same. For more details about frequency channels for our wireless products, see the Specifications.

After having made an installation check the wireless signal strength.

- The supplied software application includes a feature to check for wireless signal strength. In the RTR-500GSM Settings Utility in the "Wireless Route Settings" menu it is possible to check click signal strength.
- Note that by moving Units 20 cm in any direction may result in communication results being significantly changed.
- If no change occurs after moving the Units to several nearby locations, we strongly suggest adding one or more Repeaters (RTR-500) to enhance communication.



## Compliance Information

### FCC Statement

---



This device complies with Part 15 of the Federal Communications Commission (FCC) rules. Operation is subject to the following two conditions: (1) This device may not cause harmful interference, and (2) This device must accept any interference received, including interference that may cause undesired operation.

This equipment has been tested and found to comply with the limits for a Class B digital device, pursuant to Part 15 of the FCC Rules. These limits are designed to provide reasonable protection against harmful interference in a residential installation. This equipment generates, uses and can radiate radio frequency energy and, if not installed and used in accordance with the instructions, may cause harmful interference to radio communications. However, there is no guarantee that interference will not occur in a particular installation. If this equipment does cause harmful interference to radio or television reception, which can be determined by turning the equipment off and on, the user is encouraged to try to correct the interference by one or more of the following measures:

- Reorient or relocate the receiving antenna.
- Increase the separation between the equipment and receiver.
- Connect the equipment into an outlet on a circuit different from that to which the receiver is connected.
- Consult the dealer or an experienced radio/TV technician for help.

To comply with the limits for the Class B digital device, pursuant to Part 15 of the FCC Rules, this device must be installed in computer equipment certified to comply with the Class B limits.

All cables used to connect the computer and peripherals must be shielded and grounded. Operation with non-certified computers or non-shielded cables may result in interference to radio or television reception.

#### **Caution:**

Changes or modifications not expressly approved by the party responsible for compliance could void the user's authority to operate the equipment.

#### **FCC Radiation Exposure Statement:**

This equipment complies with FCC RF radiation exposure limits set forth for an uncontrolled environment and meets the FCC radio frequency (RF) Exposure Guidelines in Supplement C to OET65. This equipment should be installed and operated with a minimum distance of 30cm between the radiator and your body.

#### **Note about Antenna Usage:**

This device has been designed to operate with the supplied antenna only. Use of any other antenna is strictly prohibited.

---

## IC Statement

---

This device complies with RSS-210 of the Industry Canada (IC). Operation is subject to the following two conditions: (1) This device may not cause harmful interference; and (2) This device must accept any interference received, including interference that may cause undesired operation.

Ce dispositif est conforme à la norme RSS 210 d'Industrie Canada.

L'utilisation de ce dispositif est autorisée seulement aux conditions suivantes : (1) il ne doit pas produire de brouillage et (2) l'utilisateur du dispositif doit être prêt à accepter tout brouillage radioélectrique reçu, même si ce brouillage est susceptible de compromettre le fonctionnement du dispositif.

---

### Important Notice

Wireless products cannot be used in countries other than where those products have been approved for use, according to that country's wireless regulations.

T&D Corporation shall in no manner whatsoever take responsibility for the usage of these products, nor be liable in any manner for legal consequences stemming from the usage of these wireless products in unapproved areas.

---

### Notes about SIM Cards

The SIM card stores the user's cell phone number and other unique user identification information. Please take adequate care to prevent the loss or theft of your SIM card. Also, be sure to keep your PIN number in a safe place.

---

Please note that this Introductory Manual has been written based on the presupposition that the functions / specifications of the SIM card being used and the details of the contract have already been confirmed between the user and the cell phone carrier.

---

T&D Corporation shall not be responsible for any damages which a contractor, a user or a third party may suffer, whether direct or indirect, due to the inability to use communication devices.

---

# What are Base Units, Remote Units and Repeaters?

## Base Units: RTR-500GSM

A Base Unit can collect data measured by and recorded in Remote Units via wireless communication, and send the collected data either by FTP or e-mail to a server whereby the data can be downloaded to your computer via an external network, such as the Internet. Also, by setting Upper and Lower Limits, warning monitoring can be carried out for each Remote Unit at each Location.

## Remote Units: RTR-501 / 502 / 503 / 505-TC / 505-Pt

A Remote Unit is a Data Logger designed to measure and record temperature and humidity. The wireless communication range between a Remote Unit and a Base Unit, if unobstructed and direct, is about 150m (500 ft).



## Repeaters: RTR-500

If wireless communication cannot successfully be carried out due to obstacles, or if you wish to extend the wireless communication range, please add Repeater(s) between Remote Unit(s) and the Base Unit.

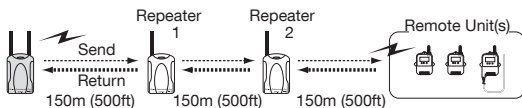

## About Registration

It is first necessary to register the desired Remote and Repeater Units (where needed) to a Base Unit. It is possible to register them into Groups by place or by purpose. Assign a Wireless Communication Frequency Channel for each Group. Remote Units and Repeaters can only be registered to one Group at a time.

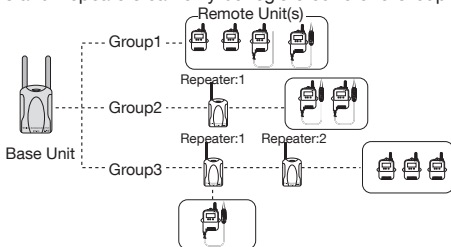

## Features of RTR-500GSM

The RTR-500GSM has the following two built-in communication capabilities: Wireless Communication with Remote Units and GSM Mobile Data Communication.

The GSM Mobile Data Communication capability makes it possible to carry out the following with temperature and humidity data received from wireless communication with Remote Units.

- **Transmission of Warning Reports by E-mail, SMS\*, or E-mail + SMS**
- **Periodic Transmission of Current Readings by E-mail or FTP**
- **Periodic Sending of Recorded Data by E-mail or FTP**

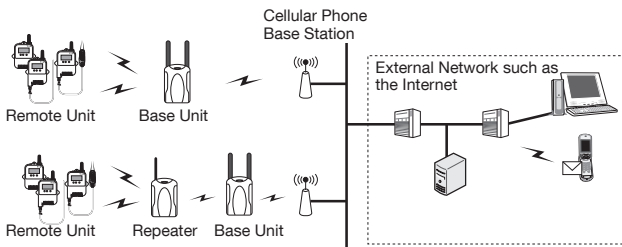

\* SMS stands for Short Message Service.

Power can be supplied via AA alkaline batteries or an external power source (an AC adaptor or an DC 8-34V external power source). If AA alkaline batteries are installed while using an external power source, the batteries will act as a backup power supply in the event the external power supply is cut for any reason.

# Basic Procedures

---

The following outline shows the basic procedures for getting ready, making settings and using the product.

- Details about making settings can be found in "Operation Guide" which is located in the drop down menu found by clicking on the program's name under [All Programs] in the [Start] Menu.

## Getting Ready

### 1. Get the Base Unit (RTR-500GSM) ready to use

Please purchase a SIM card separately.

### 2. Install the software "RTR-500GSM for Windows"

### 3. Install the USB device driver and confirm its usage

### 4. Make Initial Settings for the RTR-500GSM

From the RTR-500GSM Settings Utility in the supplied software

### 5. Get Remote Units ready to use

For details, see the Introductory Manual that accompanies the Remote Unit.

### 6. Get Repeaters ready to use (only if necessary)

For details, see the User's Manual that accompanies the Repeater Unit.

## Making the RTR-500GSM Unit Settings (using the supplied software)

### 1. Make Base Unit operational settings

### 2. Register Remote Units and Repeaters and make necessary settings

### 3. Make settings for the transmission of Current Readings, Warning Reports, and for the Auto-Downloading of Data

### 4. Carry out transmission tests



## **Getting Ready**

---

This section provides instructions on getting the RTR-500GSM ready to use.

# Package Contents

The following items are included in the package:

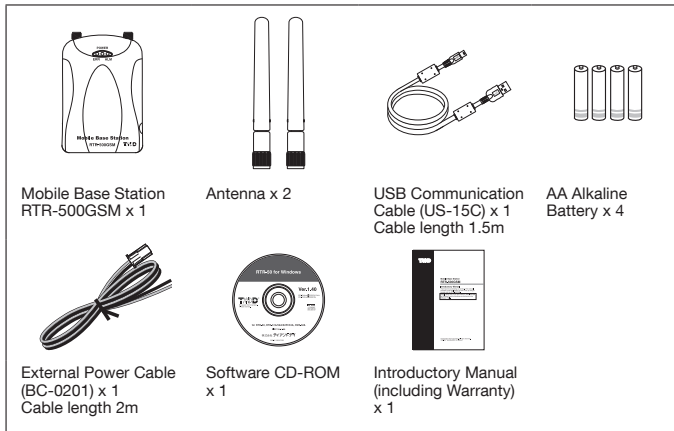

## About SIM Cards

Please purchase a SIM card separately from your cell phone carrier. RTR-500GSM can be used with any SIM card which complies with the following specifications:

- Compatible with GSM (GSM 850 or GSM 1900)
- Able to use SMS (Short Message Service) and GPRS (General Packet Radio Service)
- The card has been activated

For details contact your cell phone company or the place where you purchased the SIM card.

# RTR-500GSM Appearance Diagrams and Part Names

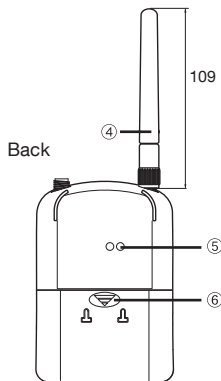
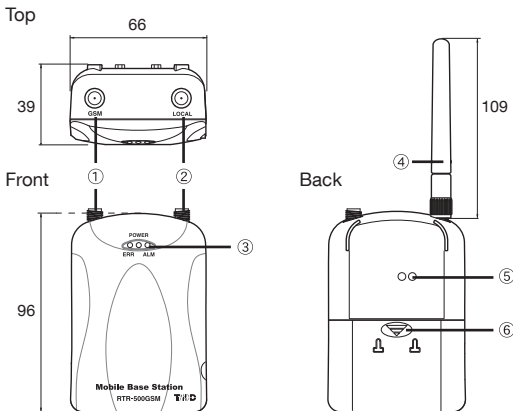

- ① GSM Antenna Connector
- ② Local Wireless Antenna Connector
- ③ LED (ERR / POWER / ALM)

- ④ Antenna
- ⑤ Optical Communication Area
- ⑥ Battery Cover

Right Side

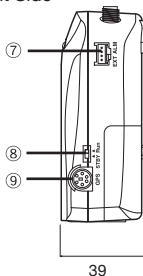

Left Side

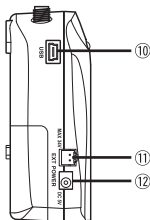

Unit : mm

- ⑦ External Contact Output / Input Connector
- ⑧ Operation Switch (STBY / Run)
- ⑨ GPS Connector (Mini DIN 6 Pin Female)

- ⑩ USB Connector (Mini-B)
- ⑪ External Power Connector
- ⑫ AC Adaptor Jack (EIAJ Voltage Classification 2)

# Getting the RTR-500GSM Ready to Use

## 1. Connect the Antennas.

Connect the two supplied antennas to the antenna connectors. (The two antennas are of the same type.)

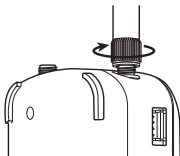

## 2. Install a SIM Card.



- When installing a card, please be careful about static electricity.
- Before installing the card, disconnect all cables (AC adaptor, USB cable and External power cable) that may be connected to the RTR-500GSM and make sure that wireless communication cannot occur.
- Be careful not to touch or scratch the IC area of the card.
- Make sure to insert the card in the proper direction.
- Do not force the cover open or closed.

### 2-1. Remove the battery cover from the back of the Unit.

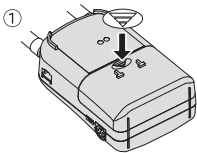

While pressing down on the triangular mark...

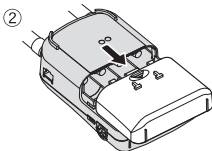

Slide the cover to the bottom of the Unit...

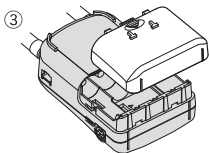

and lift off the cover.

- Replace the battery cover to as it was when opened.

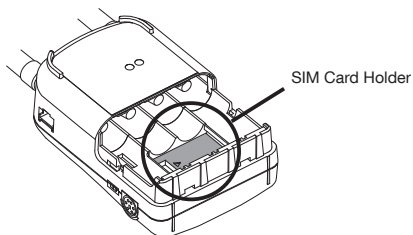

**2-2. Lightly slide the cover of the Card Holder to the right to unlock it.**

**2-3. Slowly lift up the cover to its open position.**

Slide cover to the right  
(Unlock)

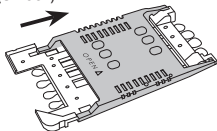

Lift up cover

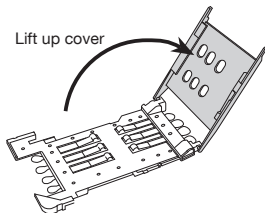

**2-4. Making sure that the IC (gold area) is facing out and toward the bottom insert the SIM card into the cover.**

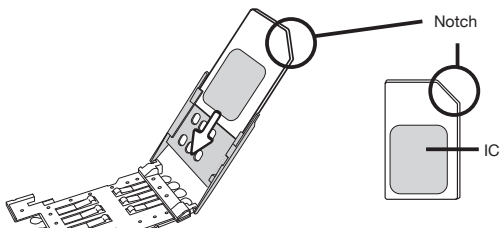

**2-5. Slowly close the cover.**

- If the cover does not close properly, make sure that the card is inserted correctly and try closing the cover again.

**2-6. Lightly slide the cover back to the left to lock it.**

- If the cover is not properly locked it may cause insufficient contact with the IC and result in a communication error.

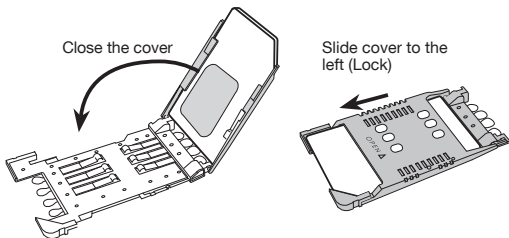

### 3. Install Batteries.

Insert 4 AA alkaline batteries, making sure that the + and - are in the correct direction as shown in the figure.

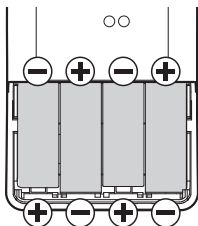

\* Leaving alkaline batteries in the unit for a long period of time may cause battery leakage and corrosion. When using as a backup source, we recommend that you change the batteries every few years.

### 4. Confirm that the RTR-500GSM has electrical power.

#### 4-1. Slide the Operation Switch to the <Run> position for operation.

<Run> Switch: Upper

<STBY> Switch: Lower



## About the Operation Switch

### Run

When the switch is set to <Run>, the functions: "Auto-download of Recorded Data", "Warning Monitoring" and "Automatic Sending of Current Readings" will become useable for the RTR-500GSM.

### STBY (Standby)

When the switch is set to <STBY>, the RTR-500GSM will go into a low energy consumption mode whereby it will be impossible to use the functions listed above.

**4-2. If any of the three LED lamps come on or blink, the RTR-500GSM has power. At this point, even if the <ERR> LED lamp comes on or blinks, it will turn off once all settings have been completed.**

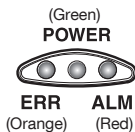

**4-3. Return the Operation Switch to <STBY>.**

Install the software. (See page 25 ~ for details)



## **Installing the Software and the USB Device Driver**

This section outlines installation procedures and cautions by Windows OS.

## Before Installing the Software

---



**Before connecting an RTR-500GSM to your computer, make sure to install the supplied software into the computer.**

If you have connected an RTR-500GSM to your computer before installing the supplied software, make sure to click the [Cancel] button in the Wizard window when it pops up on the computer display.



**Slide the Operation Switch on the RTR-500GSM to the <STBY> position.**

### Before Installing the Software

#### **Is Windows working properly?**

If Windows is not operating properly, the software may not be installed correctly or it may not operate properly.

#### **Make sure to check that the OS you are running and "RTR-500GSM for Windows" are compatible.**

Microsoft Windows 8 32/64bit

Microsoft Windows 7 32/64bit

Microsoft Windows Vista 32bit (SP1 or later)

Microsoft Windows XP 32bit (SP3 or later)

- For details about the necessary operating environment, see page 40.

#### **Quit all other applications**

If you are running other applications, make sure to quit them before installation. If you have any permanently active software, such as a virus check or scan program in your computer, make sure to also quit it.

**To install RTR-500GSM for Windows, it is necessary to have Administrator rights (Computer Administrator) for the computer in which you wish to install it.**

## RTR-500GSM for Windows Installation Procedure

1. Start Windows and login using a User Account with Administrator (Computer Administration) rights.
2. Place the CD-ROM into your CD or DVD drive.
3. The [Install Program] window will appear.

If the [Auto Play] window appears:

Click on [Run start.exe].

If the [Install Program] window does not appear automatically:

Click on the [start.exe] icon in the CD/DVD drive.



\* If you are using Windows 8, carry out the rest of the installation process on the “desktop” which can be accessed via a tile on the Start screen.

4. Select “Install RTR-500GSM for Windows” and click the [Execute] button to start the installation.

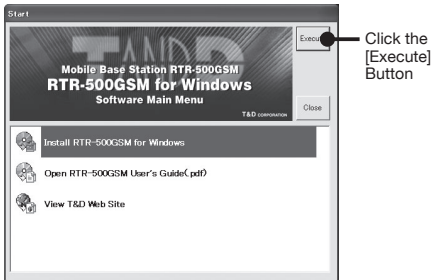

5. Follow the directions as they appear to complete the installation.

If a window appears such as the one below during installation, choose [Install] or [Continue Anyway].

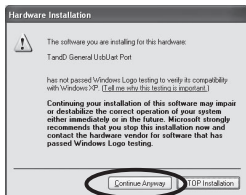
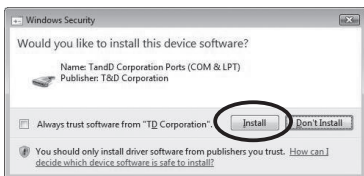

6. After installation, "RTR-500GSM for Windows" will appear in the Windows Start Screen or Start Menu.



## USB Driver for Windows XP

If you are using Windows XP, the “Found New Hardware Wizard” window will automatically open when a USB device is connected. Please follow the directions to install the USB driver.

### 1. Select “No, not this time”.

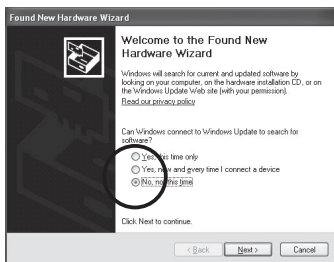

### 2. Select “Install the software automatically (Recommended)”.

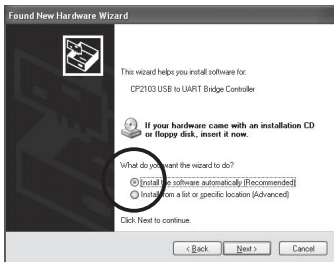

### 3. When the completion message appears, please click the [Finish] button.

**Other**

---

# Launcher Window and Applications

---

## How to Open

Open the "RTR-500GSM for Windows" from the Start Screen or Start Menu.

### Launcher Window



### Operation Guide:

This provides detailed information related to the software in general, including "Basic Procedures" and "Troubleshooting". For details about how to use each application or description of the menus, open [Help] in the application menu.

## Other Items

### RTR-500GSM Settings Utility :

This allows the user to make Base Unit settings, Register Remote Units and Repeaters, Check Signal Strength, make settings for the Downloading of Recorded Data, the Monitoring of Current Readings and Warning Monitoring. This application is also used to Start and Stop Recording in Remote Units.

### Temperature/Humidity Graph, Multi-Scale Graph :

These graph applications help users view downloaded data from Remote Units in graph and table form, as well as print or convert into text file data.

### T&D WebStorage Service :

Click here to open the T&D WebStorage Service website. Current readings and previously recorded data can be accessed via Internet by using T&D WebStorage Service.

### Introductory Manual :

This document is available in PDF file format.

### Help for Unit Recognition Failure :

Click here for information on how to check and install the USB driver.

### Update Information :

Click here for Information about software and firmware updates.



# RTR-500GSM Initial Settings

## Check the following before making initial settings

- Have the SIM card and batteries been installed correctly?
- Has the RTR-500GSM been connected with a USB cable to your computer?
- Is the Operation Switch on the RTR-500GSM set to <STBY>?
- Is the LED <Power> lamp (green) ON?

### 1. Open the RTR-500GSM Settings Utility.

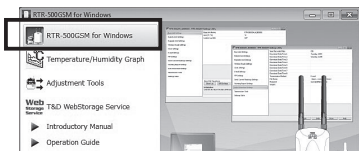

### 2. The [RTR-500GSM Initial Settings Wizard] window will automatically appear. Follow the instructions as they appear on the screen to make settings.

For details about making settings using the Initial Settings Wizard, see the explanation in the "Operation Guide" by clicking on the [Help] button.



### If the Wizard window does not automatically open:

From the "View" Menu in the RTR-500GSM Settings Utility, select "Initial Settings Wizard" to open the window.



# Remote Units and Repeaters

---

The following outline shows the procedures for connecting a Remote Unit / a Repeater to the computer.

## Connecting a Remote Unit (Optical Communication)

1. Open the software application.
2. When the direction appears in the application window, connect the Base Unit with a USB communication cable to the computer.
3. Place the Data Logger (Remote Unit) face down on the RTR-500GSM (Base Unit), making sure that the optical communication areas are aligned properly.

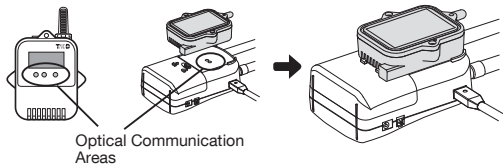

## Connecting a Repeater

1. Open the software application.
2. When the direction appears in the application window, connect the Repeater with a USB communication cable to the computer.

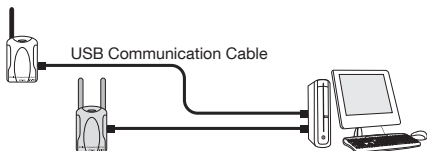

\* A Repeater can be connected to the computer simultaneously with the Base Unit as shown in the figure above.

# External Parts

## About the External Contact Output / Input Connector

The following figure shows External Output / Input Terminals and the table shows its pin assignment. Please purchase a compatible connector and cable separately.

\* The JST Connector PAP-04V-S is compatible with this product. For all inquiries and questions concerning sales of the connectors, please directly contact JST Mfg. Co., Ltd. (<http://www.jst-mfg.com/>).

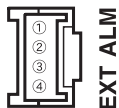

EXT ALM

	No.	Name	Specifications
Contact Input	①	Input Terminal	Internal Pull-up: 3V 100K $\Omega$ Maximum Input Voltage: 30V
	②	GND	
Contact Output	③	Output Terminal	Open drain output - Voltage when OFF: DC less than 30V - Current when ON: less than 0.1A - Resistance when ON: about 15 $\Omega$
	④	GND	

### Contact Input

ON is when contact is closed between terminal ① and ②. When the external contact input turns ON, a warning mail and/or an SMS will be sent.

### Contact Output

ON is when contact is closed between terminal ③ and ④. When a warning has been judged to have occurred, the contact output will be turned ON, making it possible to output a warning signal to an external device.

## About External Power Sources

To supply power from an external source, it is possible to use an AC adaptor or connect to some other compatible external source of power.

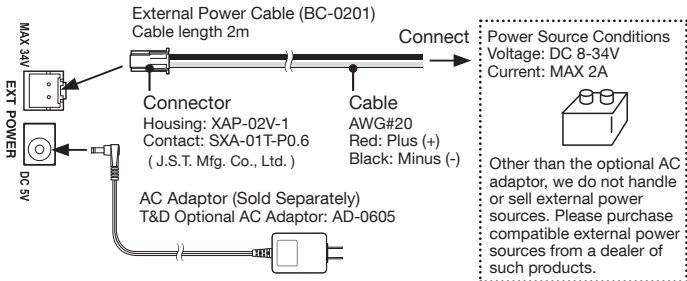

# LED Display

The color and appearance of the lamps in the LED change to show the current status of the RTR-500GSM.



## When Operation Switch is in <Run> position

LED	Status	Reason		
POWER	Blinking	In "Run" mode		
	Blinking rapidly	Communication in progress	During Wireless Communication or GSM Communication	
	Lamp OFF	RTR-500GSM is outside GSM communication range		
ERR	Blinking	Remote Unit not registered and/or Outside of communication range		
	Lamp ON	SIM card NOT installed or PIN number does not match A SIM card has been installed whose PIN number does not match that set in the RTR-500GSM		
ALM	Blinking	During Warning	Remote Unit(s)	Upper / Lower Limit Warning has occurred Battery Power is low Sensor Error Wireless Communication Error
			Base Unit	External power has been lost or disconnected (only when running on external power supply and batteries) Battery power is low External Contact Input is ON

## When Operation Switch is in <STBY> position

POWER	Lamp ON	Connected via USB
POWER	Blinking	During USB Communication
POWER ERR ALAM	Lamps OFF	No USB Connection or Failed Connection

## Tips for Placing the RTR-500GSM

---

We strongly suggest setting the RTR-500GSM Unit up in a high, unobstructed position to enhance the radio signal strength.

When positioning the Units try to keep the antennas away from objects or walls.

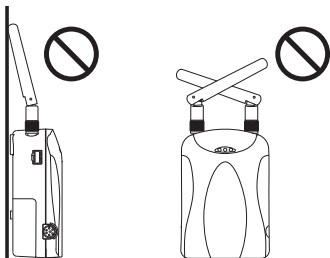

Please carry out a \*Signal Strength Test to check the radio signal strength before using the product and adjust the antenna direction accordingly. For more details please see "Notes and Precautions for Installing Wireless Communication Devices" on page 9.

\* Signal Strength Tests are tests carried out for checking the wireless signal strength between Base, Remote, and Repeater Units after the Units have been deployed and settings had been completed. Use the [Wireless Route Settings] menu in the RTR-500GSM Settings Utility to carry out this test.

# FAQ's

---

## Q&A about RTR-500GSM

### Q1: Can this be used in any country in the world?

**A:** The RTR-500GSM uses radio communication that is subject to local rules and regulations for the area in which it is being used. It is the responsibility of the user to make sure that the product complies with local rules and regulations before using it.

Also, the product can only be used in areas where GSM type cellular phone service is available.

For more details please contact the distributor from which you purchased the product.

### Q2: The LED lamps do not come on, nor do they blink, what may be wrong?

**A:** If none of the three LED lamps come on nor do they blink, please check the following:

Check to make sure that the operation switch is set to the "Run" position.

Check to make sure that the batteries are installed in the proper direction.

Please try installing new batteries.

If you are using an optional AC adaptor or have a cable connected to an external power source, check that the connection to the RTR-500GSM is OK.

If after checking and trying the above, no change occurs to the LED, please contact the dealer where the product was purchased.

### Q3: If I use batteries as the power source, about how long can I expect them to last?

**A:** Expected battery life will vary depending on the environment where it is being used and upon signal conditions. If warning monitoring is carried out every 10 minutes, you can expect new batteries to last about 10 days.

### Q4: I want to use the Unit outdoors, is the Unit waterproof, moistureproof and dustproof?

**A:** The RTR-500GSM is not waterproof, moistureproof or dustproof. If you wish to use outdoors, or in areas where the Unit may come into contact with moisture, water or excessive dust, we suggest using some type of case to place the RTR-500GSM out of which cables can be passed.

## Q5: Is it possible to change the batteries while the Unit is in operation?

- A:** If the Unit is connected to an AC adaptor or some other external power source, it is possible to change the batteries.  
If the Unit is running only on battery power, first turn the operation switch to "STBY" and then change the batteries.

## Q&A about SIM Cards and GSM

### Q1: About how much are the communication costs?

- A:** Actual costs and fees will depend on which cell phone carrier you are using. Please refer to the following when contacting your cell phone carrier about estimated costs.

Estimated Data per Type of Communication

	E-mail (*1) / FTP	SMS (*2)
Current Readings	about 3.5KB per set of data (1 Remote Unit)	n/a
Warning Reports	about 2.0 KB per report (1 Remote Unit)	One report (1 Remote Unit)
Auto-Download of Recorded Data	about 4.5 KB / 1 day of data (1 Remote Unit at recording interval of 1 min)	n/a

\*1) Includes mail header

\*2) Depending on the number of warnings, the report may be split into two or more separate reports

# Product Specifications

## RTR-500GSM

UNIT	
Compatible Devices	Remote Units: RTR-501 / 502 / 503 / 505-TC / 505-Pt, RTR-501L / 502L / 503L / 505-TCL / 505-PtL Repeater: RTR-500
Features and Functions	1. Auto-downloading of Recorded Data (E-mail or FTP), 2. Automatic Sending of Current Readings (E-mail or FTP), 3. Warning Monitoring (SMS, E-mail or Contacts) 4. SMS Remote Control - Stop and Start Functions 1, 2, 3, above - Request Immediate Download of Data to Set Address
Types of Warnings Monitoring	Remote Unit Measurement Warnings, Remote Unit Wireless Communication Error Warnings, Remote Unit Battery Level Warnings, Remote Unit Sensor Abnormality Warnings, Base Unit External Power Loss Warnings (only when batteries are installed), Base Unit Battery Level Warnings / Base Unit External Contact Input Warnings
Power	AA Alkaline Batteries x 4 External Power (DC8 - 34V) AC Adaptor AD-0605 (5V)
Current Consumption	At most 2A (5V, with GSM in operation)
Communication Interfaces	USB (with PC) Optical Communication (with Remote Unit)
LED Display	POWER: Green / ERR: Orange / ALM: Red
Battery Life	10 days of continued use if monitoring is carried out every 10 minutes (when not using GPS). * Battery life varies depending upon the frequency of communication, the measuring environment, and the quality of the batteries being used.
Dimensions	H 96 mm x W 65 mm x D 39 mm (Excluding protrusions) Antenna Length : 109mm
Weight	About. 220 g (including batteries)
Operating Environment	Temperature: 10 to 55°C (-10 to 55°C when external power connected) Humidity: 90 %RH or less (no condensation)
Other	Not waterproof, moistureproof, or dustproof.



## Short Range Wireless Communication

RF Power	7mW
Radio Standard Specifications	FCC Part15 Section247 / IC RSS-210 (Frequency Range: 902 to 928MHz )
Transmission Range	About 150m (500 ft) (if direct and unobstructed)
Communication Time	When downloading 1 Remote Unit of full data (16,000 readings): about 2 minutes * The same amount of time will be necessary for each added Repeater.

## Cellular Phone Communication

Network	GSM850/GSM1900(PTCRB Certified) GPRS(General Packet Radio Service)
Data Transfer Protocol	FTP (PASV mode also supported) SMTP (SMTP-AUTH, POP-before SMTP) * SMTP-AUTH supports LOGIN only
Warning Monitoring Function	SMS / SMTP (SMTP-AUTH, POP-before SMTP) * SMTP-AUTH supports LOGIN only

## External Alarm Input/Output Terminal (\*1)

Input Terminal	< Contact Input > Internal Pull-up: 3V 100kΩ Maximum Input Voltage: 30V
Output Terminal	< Open Drain Output > Voltage when OFF: DC 30V or less Current when ON: 0.1A or less Resistance when ON: 15Ω

1: In order to use the external alarm terminal, please prepare a compatible connector: JST PAP-04V-S.

## GPS Communication (\*2)

GPS Interface	Connector: Mini DIN 6 Pin Female Communication Standard: ANSI / EIA/TIA-232-E Geographic Coordinate System: WGS84 Power Supply: 5V MAX 100mA
---------------	---

\*2: In order to use the GPS function (attach geographical positioning info to current readings data), please purchase a compatible GPS receiver: GlobalSat BR-355. For all inquires and questions concerning sales of t

## Software (RTR-500GSM for Windows)

### Operating Environment

Compatible OS (*1)	Microsoft Windows 8 32/64bit (*2) Microsoft Windows 7 32/64bit Microsoft Windows Vista 32bit (SP1 or later) Microsoft Windows XP 32bit (SP3 or later)
Display Languages (*3)	English, Spanish

\*1: For installation, it is necessary to have Administrator (Computer Administrator) rights.

\*2: If you are using Windows 8, please note that our software is designed to be used in "Desktop" mode only.

\*3: We recommend using an operating system in the same language as the display language. Operation in different languages is not guaranteed.

The specifications listed above are subject to change without notice.

# Options

## Wall Attachment

Type: TR-5GK1

- ① O-Ring (rubber) x 1
- ② Polyurethane Foam
- ③ Aluminum
- ④ Lock Screw x 2
- ⑤ Double-sided Adhesive tape x 1

Dimension (mm):

W73 x H72 x D43

Screw Holes: 2 -  $\phi$ 4.2

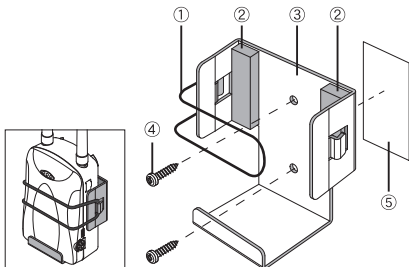

## AC Adaptor

Type: AD-0605

Input: AC 100V(90-132V)

Output: DC5V 2A

Frequency: 50/60Hz

Cable Length: 1.85m

Plug Figure: A

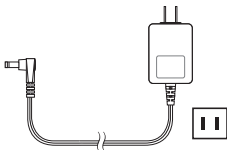

## External Power Cable

Type: BC-0201

- ① Cable: (AWG#20)  
Red Plus (+) / Black Minus (-)  
Cable Length: 2m

- ② Connector:  
Housing XAP-02V-1  
Contact SXA-01T-P0.6  
(J.S.T. Mfg. Co., Ltd.)

Power Source Conditions:

Voltage DC 8-34V

Current MAX 2A



## GPS Receiver

The GlobalSat "BR-355 Cable GPS" has been tested for use with our product.

T&D does not handle or sell GlobalSat products. For all inquiries and questions concerning sales of the product, please directly contact Globalsat Technology Corporation. (<http://www.globalsat.com.tw/>)







## **Product Support**

For support, please contact the distributor from which you purchased the product.

A list of distributors can be found at:

[http://www.tandd.com/about\\_tandd/contactus/](http://www.tandd.com/about_tandd/contactus/)

## **Product Information**

Product information can be found at:

<http://www.tandd.com/product/>

---

## **Mobile Base Station RTR-500GSM Introductory Manual**

---

### **T&D CORPORATION**

817-1 Shimadachi, Matsumoto, Nagano 390-0852, Japan

Website : <http://www.tandd.com/>

FAX : +81-263-40-3152      E-mail : [support@tandd.com](mailto:support@tandd.com)

© Copyright T&D Corporation. All rights reserved.

---

Printed on recycled paper.



## Provisions for Free Repair

The warranty is contained in the User's Manual (English) included in the package. When seeking repair, please make sure to fill in all required fields and present it.

1. If the Unit does not work properly despite the fact that the customer used it properly and in line with the Introductory Manual, the Unit shall be repaired free of charge through the distributor which sold the Unit.
2. If the customer requests free repair because of trouble within the warranty period, bring or send the Unit along with the warranty to the dealer. A service charge may be added if a repairperson must be sent out to the place of use for repair.
3. If you have moved after purchasing, or the product was received as a gift, or there are difficulties contacting the shop from which you purchased the Unit, please contact T&D directly for service.
4. Free repair is not available in the following cases even though it is within the warranty period:
  1. Trouble or damage was caused by careless operation, natural disaster, fire, public pollution, or use of a power source other than specified.
  2. If repair, adjustment, disassembly or modification of the Unit has been carried out by a person other than a T&D authorized engineer.
  3. Trouble or damage was caused by transportation, movement or dropping of the Unit after purchase.
  4. Failure to submit the Warranty or failure to fill in all items required in the Warranty.
5. The Warranty cannot be reissued.

This Warranty only promises customers free repair within the period and conditions clarified in this Warranty. Therefore, the customer's legal rights will not be limited by this Warranty. For further information on repair and others service questions after the termination of the warranty period, contact your dealer.